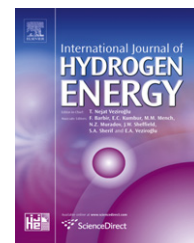

Available at www.sciencedirect.comjournal homepage: www.elsevier.com/locate/he

Effect of hydroxy (HHO) gas addition on performance and exhaust emissions in compression ignition engines

Ali Can Yilmaz, Erinċ Uludamar, Kadir Aydin*

Department of Mechanical Engineering, Çukurova University, 01330 Adana, Turkey

ARTICLE INFO

Article history:

Received 8 May 2010

Received in revised form

5 July 2010

Accepted 5 July 2010

Available online xxx

Keywords:

Hydrogen

Hydroxy

Enrichment

Combustion

Performance

Emissions

ABSTRACT

In this study, hydroxy gas (HHO) was produced by the electrolysis process of different electrolytes ($\text{KOH}_{(aq)}$, $\text{NaOH}_{(aq)}$, $\text{NaCl}_{(aq)}$) with various electrode designs in a leak proof plexiglass reactor (hydrogen generator). Hydroxy gas was used as a supplementary fuel in a four cylinder, four stroke, compression ignition (CI) engine without any modification and without need for storage tanks. Its effects on exhaust emissions and engine performance characteristics were investigated. Experiments showed that constant HHO flow rate at low engine speeds (under the critical speed of 1750 rpm for this experimental study), turned advantages of HHO system into disadvantages for engine torque, carbon monoxide (CO), hydrocarbon (HC) emissions and specific fuel consumption (SFC). Investigations demonstrated that HHO flow rate had to be diminished in relation to engine speed below 1750 rpm due to the long opening time of intake manifolds at low speeds. This caused excessive volume occupation of hydroxy in cylinders which prevented correct air to be taken into the combustion chambers and consequently, decreased volumetric efficiency was inevitable. Decreased volumetric efficiency influenced combustion efficiency which had negative effects on engine torque and exhaust emissions. Therefore, a hydroxy electronic control unit (HECU) was designed and manufactured to decrease HHO flow rate by decreasing voltage and current automatically by programming the data logger to compensate disadvantages of HHO gas on SFC, engine torque and exhaust emissions under engine speed of 1750 rpm. The flow rate of HHO gas was measured by using various amounts of KOH, NaOH, NaCl (catalysts). These catalysts were added into the water to diminish hydrogen and oxygen bonds and NaOH was specified as the most appropriate catalyst. It was observed that if the molality of NaOH in solution exceeded 1% by mass, electrical current supplied from the battery increased dramatically due to the too much reduction of electrical resistance. HHO system addition to the engine without any modification resulted in increasing engine torque output by an average of 19.1%, reducing CO emissions by an average of 13.5%, HC emissions by an average of 5% and SFC by an average of 14%.

© 2010 Professor T. Nejat Veziroglu. Published by Elsevier Ltd. All rights reserved.

1. Introduction

Faced with the ever increasing cost of conventional fossil fuels, researches worldwide are working overtime to cost-

effectively improve internal combustion engine (ICE) fuel economy and emission characteristics. In recent years, many researchers have focused on the study of alternative fuels which benefit enhancing the engine economic and emissions

* Corresponding author. Tel.: +90 5335107585; fax: +90 3223386126.

E-mail address: kdraydin@cu.cdu.tr (K. Aydin).

0360-3199/\$ – see front matter © 2010 Professor T. Nejat Veziroglu. Published by Elsevier Ltd. All rights reserved.

doi:10.1016/j.ijhydene.2010.07.040

characteristics. The main pollutants from the conventional hydrocarbon fuels are unburned/partially burned hydrocarbon (UBHC), CO, oxides of nitrogen (NO_x), smoke and particulate matter. It is very important to reduce exhaust emissions and to improve thermal efficiency. The higher thermal efficiency of diesel engines certainly has advantages for conserving energy and also solving the greenhouse problem. Among all fuels, hydrogen is a long term renewable, recyclable and non-polluting fuel. Hydrogen has some peculiar features compared to hydrocarbon fuels, the most significant being the absence of carbon. Very high burning velocity yields very rapid combustion and the wide flammability limit of hydrogen varies from an equivalence ratio (ϕ) of 0.1–7.1, hence the engine can be operated with a wide range of air/fuel ratio. The properties of hydrogen are given in Table 1 [1]. Due to the low ignition energy and wide flammable range of hydrogen, hydrogen engines are quite suitable to run at lean conditions which are helpful for the enhanced engine economic and emissions performance [2,3]. All regulated pollutant emissions, except nitrogen oxides, can be simply reduced by using a carbon-free fuel. This is true whatever the alternative fuel source if the production of this carbon-free fuel in large plants is more efficient and therefore produces less CO_2 than the direct conversion of the fuel source into mechanical power in the internal combustion engine. The combination of its molecular composition and some of its peculiar properties (high laminar flame speed, wide flammability range, etc.) reveals hydrogen as an attractive fuel for ICEs [4]. Besides, compared with traditional fossil fuels, hydrogen is a carbonless fuel whose combustion doesn't generate emissions such as HC, CO and CO_2 [5].

The concept of using hydrogen as an alternative fuel for diesel engines is recent. The self ignition temperature of hydrogen is 858 K, so hydrogen cannot be used directly in a CI engine without a spark plug or glow plug. This makes hydrogen unsuitable as a sole fuel for diesel engines [1]. There are several reasons for applying hydrogen as an additional fuel to accompany diesel fuel in CI engine. Firstly, it increases the H/C ratio of the entire fuel. Secondly, injecting small amounts of hydrogen to a diesel engine could decrease heterogeneity of a diesel fuel spray due to the high diffusivity of hydrogen which makes the combustible mixture better premixed with air and more uniform. It could also reduce the

combustion duration due to hydrogen's high speed of flame propagation in relation to other fuels [6].

Throughout history, there have been many studies regarding hydrogen as a fuel in ICEs. First, Reverend Cecil in England planned to use hydrogen as fuel in 1820. Bursanti and Matteucci in Italy improved the hydrogen engine with a free piston in 1854. Rudolf Erren conducted studies with the hydrogen engine in Germany in 1920. Ricardo achieved high efficiency when working with hydrogen in an engine in 1924 [7]. In 1992, as a result of the Second World Renewable Energy Congress held in Reading, the world renewable energy network (WREN) has been formed. The first author of this paper is the founder member of WREN. This network is dedicated to promoting renewable energy throughout the world [8]. Also, there have been many investigations on hydrogen-enriched fuel operation in ICEs. Saravanan and Nagarajan [9] experimentally investigated the hydrogen-enriched air induction in a diesel engine system. The test results showed that an efficiency of 27.9% was achieved without knocking over the entire load range with 30% hydrogen enrichment. Also, they observed that specific fuel consumption decreased with increase in hydrogen percentage over the entire range of operation. Saravanan et al. [10] did an experimental investigation on hydrogen as a dual fuel for diesel engine system with exhaust gas recirculation (EGR) technique. The test results demonstrated that the SFC decreased without EGR with 20 L/min of hydrogen flow and they concluded that the reason for reduction in SFC is due to the operation of hydrogen fueled engine under lean burn conditions. Masood et al. [11] studied on experimental verification of computational combustion and emission analysis of hydrogen–diesel blends and the test results showed that the hydrogen–diesel co-fueling solved the drawback of lean operation of hydrocarbon fuels such as diesel, which were hard to ignite and resulted in reduced power output, by reducing misfires, improving emissions, performance and fuel economy. Saravanan and Nagarajan [12] studied on an experimental investigation on optimized manifold injection in a direct-injection diesel engine with various hydrogen flowrates. The test results showed that in the manifold injection technique, the optimized condition was the start of injection at gas exchange top dead center (TDC) with injection duration of 30° crank angle (CA) with a hydrogen flow rate of

Table 1 – The properties of hydrogen.

Properties	Diesel	Unleaded gasoline	Hydrogen
Autoignition temperature (K)	530	533–733	858
Minimum ignition energy (mJ)	–	0.24	0.02
Flammability limits (volume % in air)	0.7–5	1.4–7.6	4–75
Stoichiometric air-fuel ratio on mass basis	14.5	14.6	34.3
Limits of flammability (equivalence ratio)	–	0.7–3.8	0.1–7.1
Density at 16 °C and 1.01 bar (kg/m^3)	833–881	721–785	0.0838
Net heating value (MJ/kg)	42.5	43.9	119.93
Flame velocity (cm/s)	30	37–43	265–325
Quenching gap in NTP air (cm)	–	0.2	0.064
Diffusivity in air (cm^2/s)	–	0.08	0.63
Research octane number	30	92–98	130
Motor octane number	–	80–90	–

7.5 L/min. The brake thermal efficiency was increased by 9% compared to pure diesel fuel operation. CO emissions varied from 0.03 to 0.12 vol% compared to 0.08–0.14 vol% in a diesel fuel investigation. Naber and Siebers [13] successfully investigated the hydrogen autoignition process under diesel conditions. The autoignition of hydrogen was investigated in a constant-volume combustion vessel. The varied parameters were as follows: the injection pressure and temperature, the orifice diameter, and the ambient gas pressure, temperature and composition. They obtained a strong Arrhenius correlation between ignition delay and temperature. Senthil et al. [14] conducted research on applying hydrogen to improve combustion of vegetable oil in a diesel engine. In their work, experiments were conducted to evaluate the engine performance while using small quantities of hydrogen in a compression ignition engine primarily fueled with a vegetable oil, namely *Jatropha* oil. Results indicated an increase in the brake thermal efficiency from 27.3% to a maximum of 29.3% at 7% of hydrogen mass share at the maximum power output. They also noticed significant smoke reduction by 20%. There was also a reduction in HC and CO emissions from 130 to 100 ppm and 0.26–0.17% (by volume), respectively, at maximum power output.

The ability for H_2 ICEs to burn cleanly and operate efficiently is owed to the unique combustion characteristics of hydrogen that allow ultra-lean combustion with dramatically reduced NO_x production and efficient low-engine load operation. In contrast, the same combustion characteristics impose technical challenges at high engine-loads due to an increased propensity to preignite the hydrogen–air mixture [15]. At low loads, the load can be controlled by the equivalence ratio (qualitative approach), as combustion temperatures then stay below the NO_x formation temperature. The engine is then run under wide open throttle conditions, so that pumping losses are negligible which benefits the brake thermal efficiency. However, hydrogen may cause some problems at high engine-loads [16]. Hydrogen has high autoignition temperature compared to diesel and this causes some challenges on operating a diesel engine just by increasing compression ratio. Therefore, a glow plug or a spark plug (external ignition sources) should be often used. Also hydrogen usage as a sole fuel in spark ignition engine brings some disadvantages to be overcome like backfire, pre-ignition and knock. Therefore, hydrogen control in engine should be managed by an electronic system. Since hydrogen has the smallest molecular size and is the lightest element in nature, its storage becomes a crucial problem. While electrochemically reacting hydrogen in fuel cells is considered to be the cleanest and most efficient means of using hydrogen, it is believed by many to be a technology of the distant future. Currently, fuel cell technology is expensive and bulky. In the near term, the use of hydrogen in an ICE may be feasible as a low-cost technology to reduce emissions of criteria pollutants and global warming via carbon dioxide (CO_2) [17].

The aim of this experimental investigation was, to make a spectacular combination of anodes and cathodes in a simply adaptable ambient within the fuel system and to obtain an enhancement in combustion and reduction in exhaust emissions with electrolysis reaction without the need for storage tanks. In this experimental study, instead of pure hydrogen addition to diesel fuel, produced hydrogen gas along with

oxygen (hydroxy gas, HHO, Brown's gas) was fed to the intake manifold of a direct-injection CI engine by a hydroxy system and a hydroxy electronic control unit (HECU) under various loads, which caused engine speed to decrease from 2800 to 1200 rpm. Hydroxy gas is in brown color and the form of unseparated hydrogen and oxygen generated by the electrolysis process of water (NaOH, KOH or NaCl additives for more HHO production and optimum molality to keep electrical resistance-conductivity balance) by a unique electrode design. Hydrogen and oxygen did not form into O_2 and H_2 molecules. They were in their monoatomic state (a single atom per molecule). Water was split by electricity to form its various elements, oxygen and hydrogen. When HHO mixture was ignited, both explosion and implosion occurred to form water, releasing the energy that was found in the bonds of the two elements in the form of heat. In the monoatomic portion, there weren't any atomic bonds needed to be broken (the bonds of the H_2 and O_2 respectively) before turning back into water. The key difference of HHO gas was the fact that some of the hydrogen and oxygen never go into a diatomic state. Hence, HHO gas had more energy because these bonds were never made. In this state, which was an unstable state of H_2O vapor, more energy was achieved compared to hydrogen burning with oxygen. Pulverized water clashed the fuel and they united. Water became the core and the fuel tended to be the water shell (due to density difference). During compression stroke, pressure and heat increased, the water exploded to steam and consequently, the fuel got atomized. After ignition, in-cylinder temperature increased rapidly which resulted water to be splitted into hydrogen and oxygen and reignition occurred which yielded increased combustion efficiency. Due to the oxygen atoms coming out with hydrogen (monoatomic structure), autoignition temperature of hydroxy was not as high as hydrogen (diatomic structure). Thus, hydroxy gas did not need an external ignition source like spark or glow plug and due to the simultaneous production and consumption of hydrogen; no storage was necessary, which resulted in safe operation [18]. Hydroxy gas was generated and used as a sole fuel in diesel engine to benefit from peculiar features and minimize disadvantages of hydrogen. It was observed that hydroxy system provided advantages in engine performance, emissions and specific fuel consumption at high engine speeds under lean conditions. At mid and low speeds, these specifications turned into disadvantages, due to minimum ignition energy of hydroxy which is a strongly decreasing function of equivalence ratio, pre-ignition and knock occurred. Also, low lean-flammability limit of hydroxy resulted advantages only under dilute (lean) conditions unless HECU was added to the HHO system. Experiments without HECU demonstrated that, compared to pure diesel fuel operation, engine torque was increased by an average of 27.1% above the engine speed of 1750 rpm and decreased by an average of 46.9% under 1750 rpm. An average reduction of 23.8% (>1750 rpm) and increment of 22.7% (<1750 rpm) in HC emissions were observed. An average of 2.1% (>1750 rpm) reduction and 4.6% (<1750 rpm) increment were observed for CO emissions. The average values for SFC were 13% reduction above 1750 rpm and 15.8% increment below 1750 rpm. Average values, obtained from experiments with HECU addition to the hydroxy system, were 19.1%

increment for engine torque, 13.5% reduction for CO emissions, 5% reduction for HC emissions and 14% reduction for SFC at all engine speeds.

2. Experimental set-up and procedure

The hydroxy system was added to the engine without any modification. HHO gas was generated in reactor container (plexiglass) by various types of electrodes (reactors) in various molality aqueous solutions of catalysts. The positive current positively charged the anodes which yielded the electrolysis reaction of the electrolytic solution and eventually released gaseous oxygen and hydrogen were generated which, in turn, surfaced at the top portion of reactor container. Electrical power that fed the electrodes was measured and it was observed that reaction field was the major factor that influenced the amount of hydroxy gas generated. Experiments on aqueous solutions of catalysts demonstrated that HHO gas flowrate increased in relation to mass fraction of catalyst in water. However, if the molality of NaOH in solution exceeded 1% by mass, current supplied from battery increased dramatically due to the too much reduction of total electrical resistance. The plate electrode and $\text{NaOH}_{(\text{aq})}$ were found the most efficient reactors and catalysts in relation to electrical power consumed. Technical specifications of the engine used in this experimental study are shown in Table 2.

An electronic control unit was designed and manufactured to decrease HHO flow rate by decreasing voltage and current. Experiments depicted that voltage around 7.3 V and current around 5.9 A were suitable values for the engine speed below 1750 rpm and data logger was programmed according to these values. HECU was designed according to working principles of a Pulse Width Modulation (PWM) Circuit based on the 555 Timer which is the process of switching the power to a device on and off at a given frequency, with varying on and off times with aid of a Metal Oxide Semiconductor Field Effect Transistor (MOSFET). IRFZ46N MOSFET was used due to its high electrical current endurance (50 A) and high triggering capacity. Schematic diagram of the circuit and pin descriptions for the 555 Timer are shown in Fig. 1 and Table 3 respectively.

Electrodes were made of 316L stainless steel due to its high corrosion resistance. Every test was repeated three times and averages were taken as results. A multimeter was used to measure output voltage and current, a flowmeter was used to

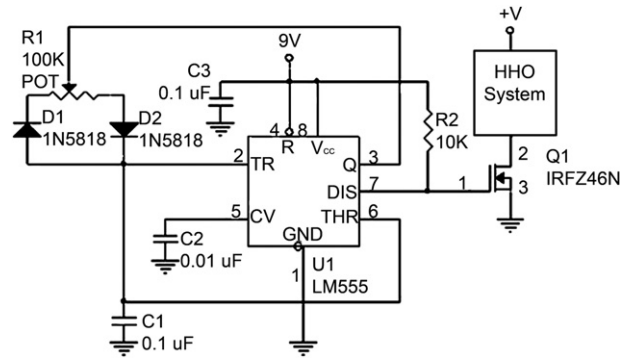

Fig. 1 – Schematic diagram of the hydroxy electronic control unit (HECU).

measure the flow rate of hydroxy gas and a gas analyzer was used to observe the exhaust emissions. Technical specifications of the HHO system are given in Table 4.

A float system was assembled into the reactor container to prevent short circuits through hydroxy gas expanded in reaction pot. Dynamometer which has a torque range of 0–1700 Nm, speed range of 0–7500 rpm was connected with the engine to control the speed by automatically adjusting the

Table 3 – Pin descriptions for the 555 Timer.

Pin	Description	Purpose
1	Ground	DC Ground
2	Trigger	The trigger pin triggers the beginning of the timing sequence. When it goes LOW (0), it causes the output pin to go HIGH (1). The trigger is activated when the voltage falls below 1/3 of +V on pin 8.
3	Output	The output pin is used to drive external circuitry. It has a “totem pole” configuration, which means that it can source or sink current. The HIGH (1) output is usually about 1.7 V lower than +V when sourcing current. The output pin can sink up to 200 mA of current. The output pin is driven HIGH (1) when the trigger pin is taken LOW (0). The output pin is driven LOW (0) when the threshold pin is taken HIGH (1), or the reset pin is taken LOW (0).
4	Reset	The reset pin is used to drive the output LOW, regardless of the state of the circuit.
5	Control Voltage	The control voltage pin allows the input of external voltages to affect the timing of the 555 chip. When not used, it should be bypassed to ground through a 0.01 μF capacitor.
6	Threshold	The threshold pin causes the output to be driven LOW when its voltage rises above 2/3 of +V.
7	Discharge	The discharge pin shorts to ground when the output pin goes HIGH. This is normally used to discharge the timing capacitor during oscillation
8	+V	DC Power/+3 to +18VDC

Table 2 – Technical specifications of the engine.

Configuration	In-line 4
Type	Direct-injection diesel with glow plug
Swept volume	3567 cm^3
Bore	104 mm
Stroke	105 mm
Oil cooler	Water-cooled
Maximum torque	255 Nm at 1800 rpm
Maximum brake power	80 kW at 3500 rpm
Recomended maximum speed	3600 rpm

Table 4 – Technical specifications of the HHO system.

Maximum gas supply	5 L/min
Electrodes (anode–cathode)	316L stainless steel plates
Maximum electrolysis voltage and current (≥ 1750 rpm)	12 V–10 A
Electrolysis voltage and current (≤ 1750 rpm with HECU)	7.3 V–5.9 A
Electrolyte (1% by mass)	NaOH aqueous solution
Reactor container volume	8.5 L
Water level control	Float system
Water temperature	40–45 °C
Dimensions	170 × 400 mm (diameter × height)
Weight	3.5 kg

load. The engine speed, power output, SFC, HC and CO emissions were measured by the computer via a data logging software. Hydroxy gas was firstly sent to a water safety system to prevent backflash using a 1/3 water-filled pot before being sent to the intake manifold. Sensors were located on the container to observe excess growth of water temperature and gas pressure. A return-safety valve was used to prevent rising of gas pressure over 1 bar in the container. General view of experimental set-up is shown in Fig. 2.

3. Results and discussion

3.1. Engine torque

Fig. 3 shows the variation of engine torque with engine speed. An average of 19.1% increment in engine torque is obtained with using HHO system compared to pure diesel operation. The increase in power is due to oxygen concentration of hydroxy gas and better mixing of hydroxy with air and fuel that yield enhanced combustion. High laminar flame velocity of hydroxy yields decreased ignition delay and shorter combustion period that provides lower heat losses, much

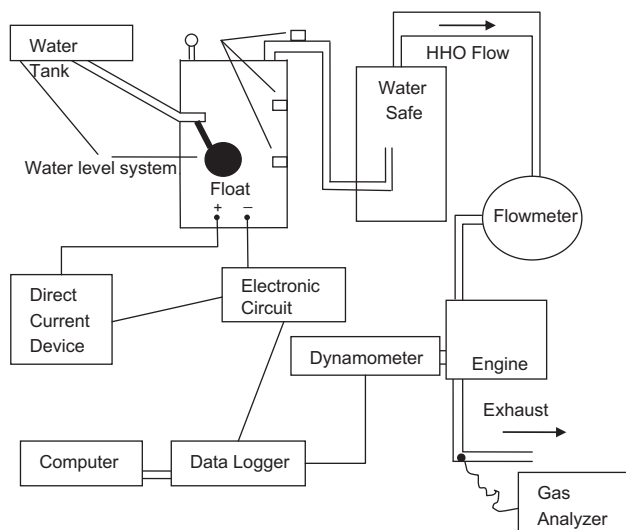
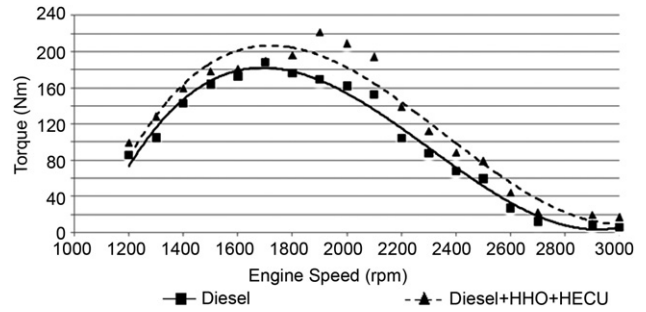
**Fig. 2 – General view of the experimental set-up.****Fig. 3 – Variation of engine torque with engine speed.**

closer to ideal constant-volume combustion which results increased compression ratio and thermal efficiency. High burning velocity of hydroxy provides faster increment in pressure and temperature which may minimize the knocking especially at idle conditions (low or no load). Also, ignition delay period reduction yields diminished engine noise. The results show that the addition of hydroxy can significantly enlarge the flammable region and extend the flammability limit to lower equivalence ratios. At high speeds (≥ 1750 rpm) the weakened in-cylinder charge flow and increased residual gas fraction are formed, which block the fuel to be fast and completely burnt. Since hydroxy has a low ignition energy and fast flame speed, the hydroxy–diesel mixture can be more easily ignited and quickly combusted than the pure diesel fuel. Thus, improved torques at high speeds can be obtained. Low lean-flammability limit of hydroxy gas allows stable combustion at highly dilute (lean) circumstances. However, it is observed that hydroxy gas cannot have a positive effect on power output at around stoichiometric (richer) conditions. Since the energy density of hydrogen on volume basis is much lower than that of diesel fuel, the reduced fuel energy flow rate is attained and finally results in the dropped engine torque at low speeds. The impairments of HHO at low speeds can be turned into advantages with the aid of HECU.

3.2. SFC

The variation SFC with engine speed is shown in Fig. 4. An average gain of 14% is achieved on SFC by using hydroxy

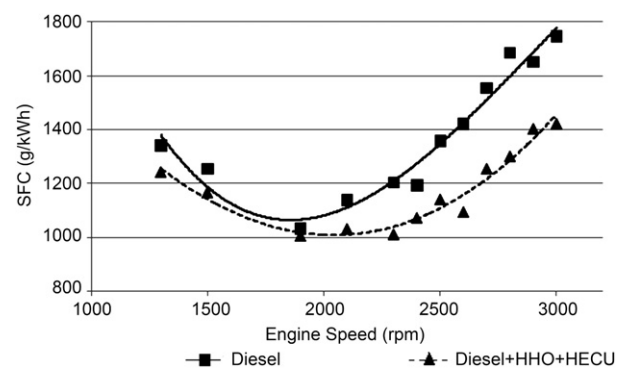
**Fig. 4 – Variation of specific fuel consumption (SFC) with engine speed.**

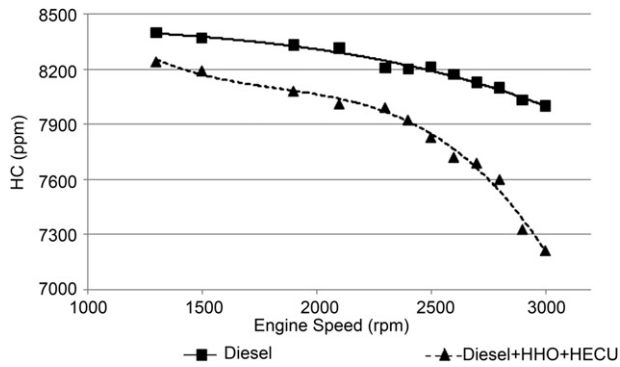

Fig. 5 – Variation of hydrocarbon (HC) emissions with engine speed.

system. Brake thermal efficiency is usually used to symbolize the engine economic performance. The improvement in engine brake thermal efficiency for the hydroxy enriched CI engine is more evidently seen at high speed conditions. The reduction in SFC is due to uniform mixing of hydroxy with air (high diffusivity of hydroxy) as well as oxygen index of hydroxy gas which assists gasoline during combustion process and yields better combustion. This can be attributed to that, at high speeds, the diesel fuel is hard to be completely burnt at lean conditions due to the increased residual gas fraction and poor mixing. Since HHO gains a high flame speed and wide flammability, the addition of hydrogen would help the fuel to be burned faster and more complete at high speed conditions. Also, low ignition energy of hydroxy–air mixture derives diesel fuel even to be burned safely under leaner conditions. However, at low speeds (≤ 1750 rpm), low lean-flammability limit prevents hydroxy to have positive influence on combustion efficiency due to mixture requirement around stoichiometric conditions. Increased CR may cause pre-ignition and high volume occupation of hydroxy causes reduced volumetric efficiency unless HECU is included to the system.

3.3. HC emissions

The variation of HC emission with engine speed is depicted in Fig. 5. An average reduction of 5% at HC emission is achieved above the engine speed of 1750 rpm. At high speed conditions,

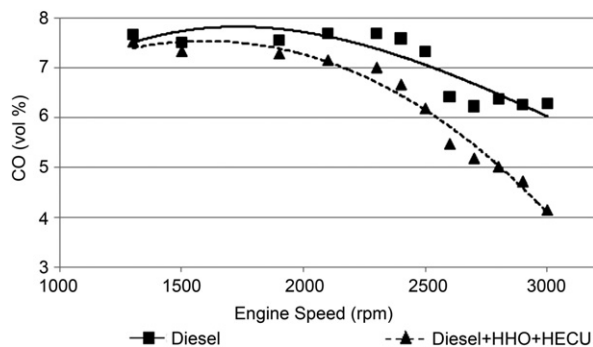

Fig. 6 – Variation of carbon monoxide (CO) emissions with engine speed.

short opening time of manifolds prevents adequate air to be taken into the cylinder and diesel fuel cannot be burned sufficiently. Short quenching distance and wide flammability range of hydrogen yield engine to expel less HC emissions especially under high speed conditions and low speed conditions with the aid of HECU. Besides, oxygen index of hydroxy yields better combustion which diminishes HC emission. At low engine speeds, due to high volume occupation of HHO gas, correct air cannot be taken into the cylinders which prevents fuel to be combusted completely. Besides, higher in-cylinder pressure, temperature and high volume occupation of hydroxy especially at low engine speeds may increase soot formation if HHO flow rate is not diminished at about 1.6 L/min.

3.4. CO emissions

Fig. 6 shows the variation of CO emissions with engine speed. An average reduction of 13.5% is gained at CO emissions at mid and higher engine speeds (≥ 1750 rpm). Absence of carbon in hydroxy gas is a major reason for CO reduction. Wide flammability range and high flame speed of hydroxy ensure engine to be operated at low loads. The HHO–diesel fuel mixture burns faster and more completely than the pure diesel fuel operation. Thus, CO emission at high speed and lean conditions is effectively reduced after HHO addition. Since HHO gas contains oxygen, higher combustion efficiency is obtained and increment for CO emission is slower unless HHO flow rate is diminished to appropriate flow rate values while approaching low speeds.

4. Conclusions

At mid and higher engine speeds; the HHO system with diesel fuel yields higher engine torque output compared to pure diesel fueled engine operation unless HECU is added to the system. High burning velocity and low ignition energy of hydroxy–air mixture minimize the effect of the weakened in-cylinder charge flow and increased residual gas fraction which block the fuel to be fast and completely burnt at high speeds. However, increased CR may cause pre-ignition and this can be minimized by direct HHO injection into the cylinder. At low engine speeds, low lean-flammability limits of hydroxy causes challenges at higher equivalence ratios. Due to the long opening time of intake manifold at low speeds, high volume occupation (reduced volumetric efficiency) of HHO becomes inevitable. Since minimum ignition energy of hydroxy–air mixture is a decreasing function of equivalence ratio till stoichiometric (richer) conditions, torque is reduced after HHO gas addition. A control unit has to be used to obtain appropriate electrolysis voltage and current (gas flow rate) to terminate the impairments of hydroxy gas at low speeds.

- Uniform and improved mixing of hydroxy–air and oxygen content of HHO stimulate combustion which has a major effect on SFC by using an adequate capacity system. Wide flammability range, high flame speed and short quenching distance of hydroxy yield diesel fuel to be combusted completely under high speed conditions without HECU and low speed conditions with HECU.

- High burning velocity, wide flammability range, oxygen content and absence of carbon make HHO gas an appropriate fuel addition to obtain adequate combustion which yield reputable reduction of HC and CO emissions when a sufficient hydroxy system is used at mid and higher speeds of engine without HECU and low speed conditions with HECU.
- A control unit, which decreases electrolysis voltage and current automatically when the engine speed decreases under 1750 rpm (critical speed for this experiment), has to be designed and manufactured to eliminate the impairments of hydroxy enriched diesel fuel combustion at low speeds and to provide energy economy.

REFERENCES

- [1] Saravanan N, Nagarajan G, Dhanasekaran C, Kalaiselvan KM. Experimental investigation of hydrogen port fuel injection in DI diesel engine. *Int J Hydrogen Energy* 2007;32:4071–80.
- [2] Andrea TD, Henshaw PF, Ting DSK. The addition of hydrogen to a gasoline-fueled SI engine. *Int J Hydrogen Energy* 2004;29:1541–52.
- [3] Ma F, Wang Y. Study on the extension of lean operation limit through hydrogen enrichment in a natural gas spark-ignition engine. *Int J Hydrogen Energy* 2008;33:1416–24.
- [4] Knop V, Benkenida A, Jay S, Colin O. Modelling of combustion and nitrogen oxide formation in hydrogen fuelled internal combustion engines within a 3D CFD code. *Int J Hydrogen Energy* 2008;33:5083–97.
- [5] Ganeshb RH, Subramaniana V, Balasubramanianb V, Mallikarjuna JM, Ramesh A, Sharma RP. Hydrogen fueled spark-ignition engine with electronically controlled manifold injection: an experimental study. *Renew Energ* 2008;33:1324–33.
- [6] Szwaja S, Rogalinski KR. Hydrogen combustion in a compression ignition diesel engine. *Int J Hydrogen Energy* 2009;34:4413–21.
- [7] Akansu SO, Dulger Z, Kahraman N, Veziroğlu TN. Internal combustion engines fueled by natural gas—hydrogen mixtures. *Int J Hydrogen Energy* 2004;29:1527–39.
- [8] Momirlan M, Veziroğlu TN. The properties of hydrogen as fuel tomorrow in sustainable energy system for a cleaner planet. *Int J Hydrogen Energy* 2005;30:795–802.
- [9] Saravanan N, Nagarajan G. An experimental investigation of hydrogen-enriched air induction in a diesel engine system. *Int J Hydrogen Energy* 2008;33:1769–75.
- [10] Saravanan N, Nagarajan G, Kalaiselvan KM, Dhanasekaran C. An experimental investigation on hydrogen as a dual fuel for diesel engine system with exhaust gas recirculation technique. *Renew Energ* 2008;33:422–7.
- [11] Masood M, Ishrat MM, Reddy AS. Computational combustion and emission analysis of hydrogen–diesel blends with experimental verification. *Int J Hydrogen Energy* 2006;32:2539–47.
- [12] Saravanan N, Nagarajan G. An experimental investigation on optimized manifold injection in a direct-injection diesel engine with various hydrogen flowrates. *Proc Inst Mech Eng D J Auto Eng.* 2007;221:1575–84.
- [13] Naber JD, Siebers DL. Hydrogen combustion under diesel engine conditions. *Int J Hydrogen Energy* 1998;23:363–71.
- [14] Senthil KM, Ramesh A, Nagalingam B. Use of hydrogen to enhance the performance of a vegetable oil fuelled compression ignition engine. *Int J Hydrogen Energy* 2003;28:1143–54.
- [15] White CM, Steeper RR, Lutz AE. The hydrogen fueled internal combustion engine: a technical review. *Int J Hydrogen Energy* 2006;31:1292–305.
- [16] Verhelst S, Maesschalck P, Rombaut N, Sierens R. Increasing the power output of hydrogen internal combustion engines by means of supercharging and exhaust gas recirculation. *Int J Hydrogen Energy* 2009;34:4406–12.
- [17] Heffel JW. NO_x emission and performance data for a hydrogen fueled internal combustion engine at 1500 rpm using exhaust gas recirculation. *Int J Hydrogen Energy* 2003;28:901–8.
- [18] Dulger Z, Ozcelik KR. Fuel economy improvement by on-board electrolytic hydrogen production. *Int J Hydrogen Energy* 2000;25:895–7.